

## AVAILABLE STYLES (see page 7 for more styles)



12"=-01  
16"=-02  
18"=-03  
20"=-31  
22"=-32



12"=-09  
16"=-10  
18"=-11  
20"=-51  
22"=-52



12"=-04  
16"=-05  
18"=-06  
20"=-41  
22"=-42

Bumpers shown below are for MOUNTING and OPTIONS. To select a style use the two digit outside shape shown above as the last two digits of the part number.

### 1980-1984 COE AND CONV. 92" LONG

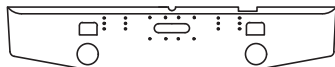

CA-1110-\_\_

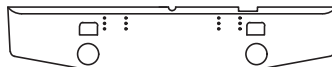

CA-1100-\_\_

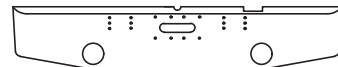

CA-1010-\_\_

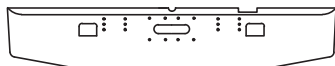

CA-0110-\_\_



CA-1000-\_\_



CA-0100-\_\_

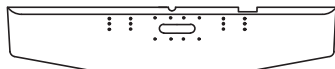

CA-0010-\_\_



CA-0000-\_\_

### 1984-1999 COE AND CONV. 92" LONG FREIGHTLINER CLASSIC

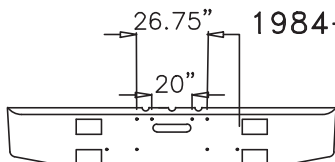

CB-2110-\_\_

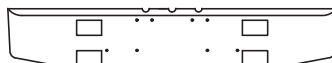

CB-2100-\_\_



CB-2010-\_\_

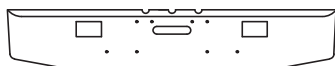

CB-0110-\_\_



CB-2000-\_\_



CB-0100-\_\_

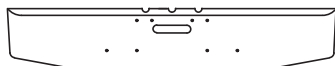

CB-0010-\_\_

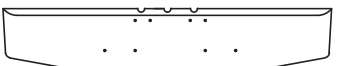

CB-0000-\_\_



CB-2010-02



**VF120009**  
FL-TOW PIN COVER -CLASSIC -  
CLASSIC X L  
FITS CA& CB SERIES

## AVAILABLE STYLES (see page 7 for more styles)

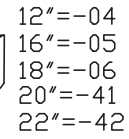
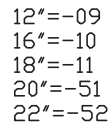
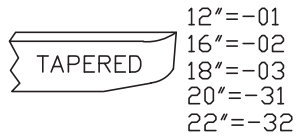

Bumpers shown below are for MOUNTING and OPTIONS. To select a style use the two digit outside shape shown above as the last two digits of the part number.

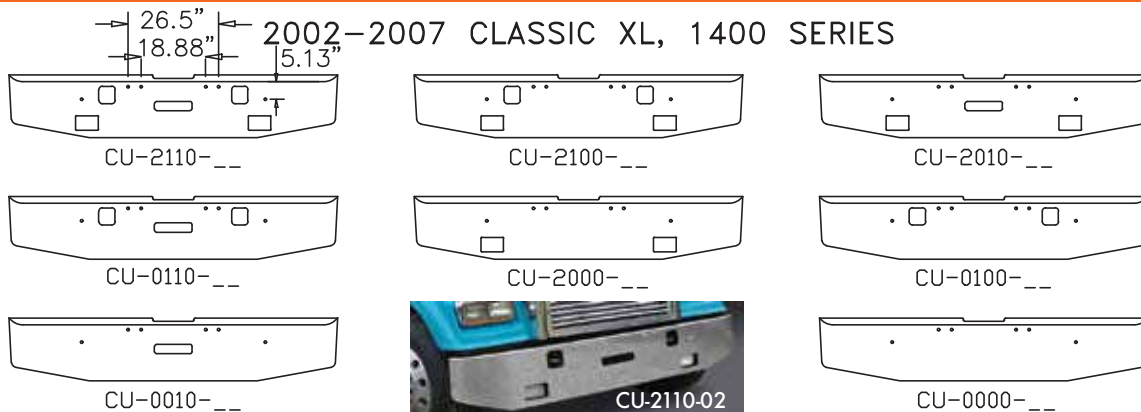
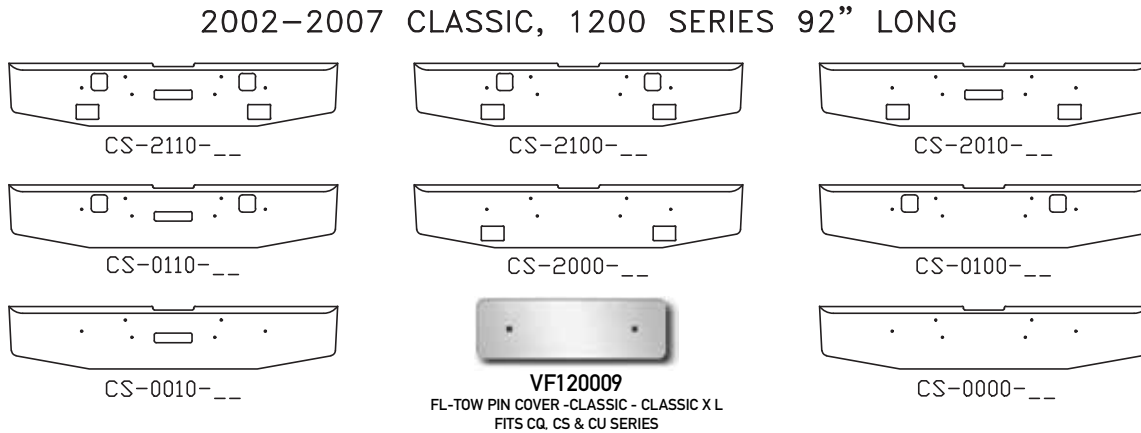
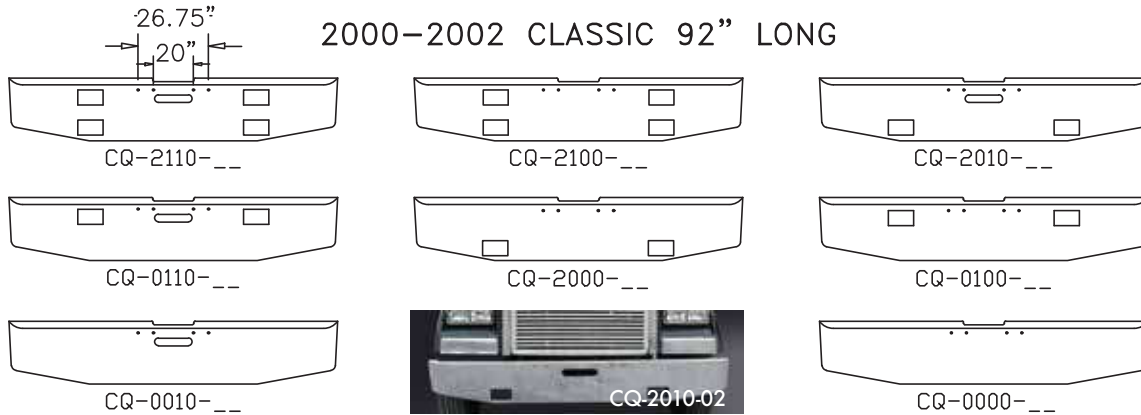

## AVAILABLE STYLES (see page 7 for more styles)

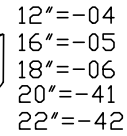
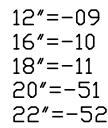
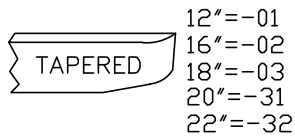

Bumpers shown below are for MOUNTING and OPTIONS. To select a style use the two digit outside shape shown above as the last two digits of the part number.

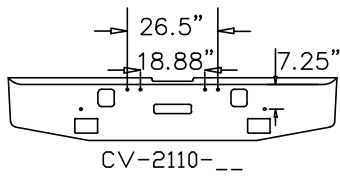

### 2002-2007 CLASSIC XL

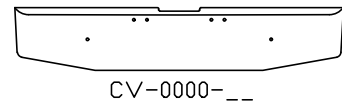
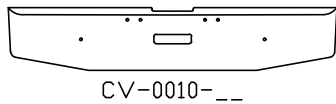
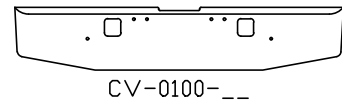
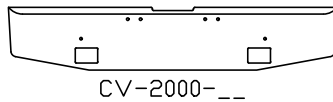
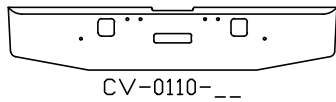
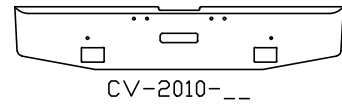
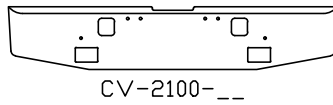

### 2008-2010 CLASSIC XL (only available in 16" or wider)

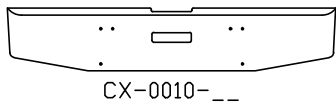
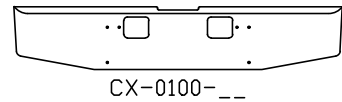
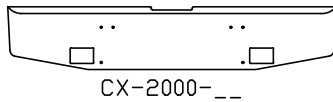
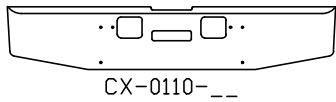
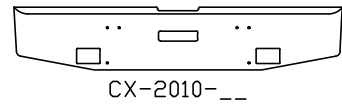
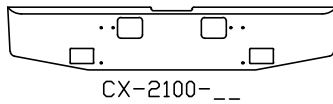
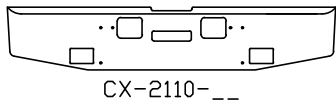

FL-TOW PIN COVER -CLASSIC - CLASSIC X L  
FITS CV & CX SERIES

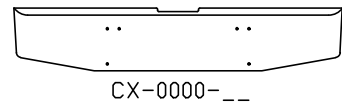

### 2012 AND NEWER 114SD SET FORWARD AXLE

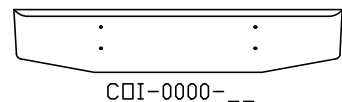
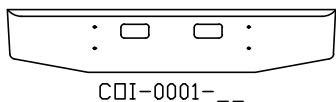
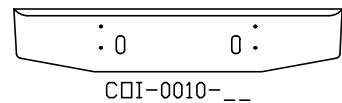
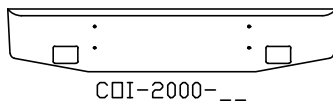
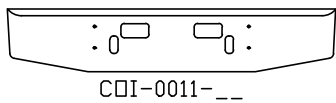
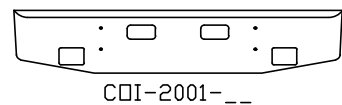
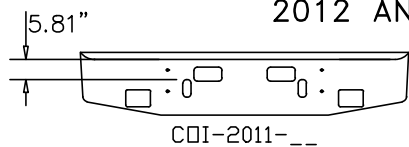

## AVAILABLE STYLES (see page 7 for more styles)

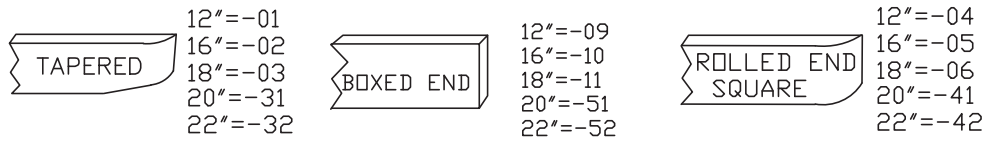

Bumpers shown below are for MOUNTING and OPTIONS. To select a style use the two digit outside shape shown above as the last two digits of the part number.

### 2002-2009 CORONADO, 2010-NEWER GLIDER KITS

(factory grill not included, not available in stainless steel)

(does not use factory support brackets or end caps)

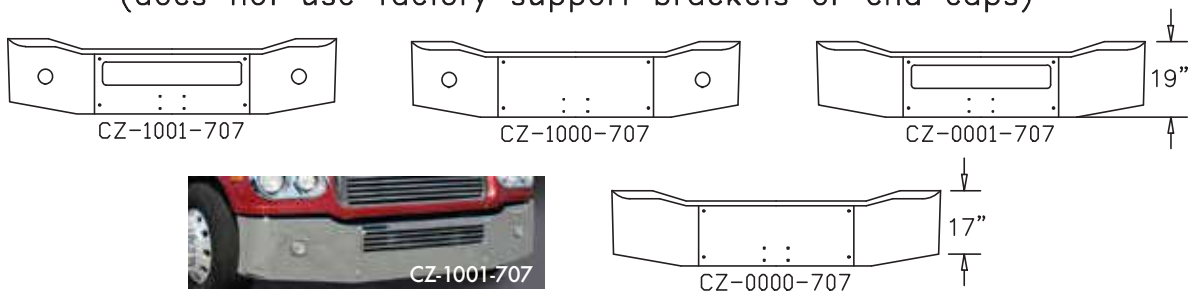

### 2010 AND NEWER CORONADO, 122SD

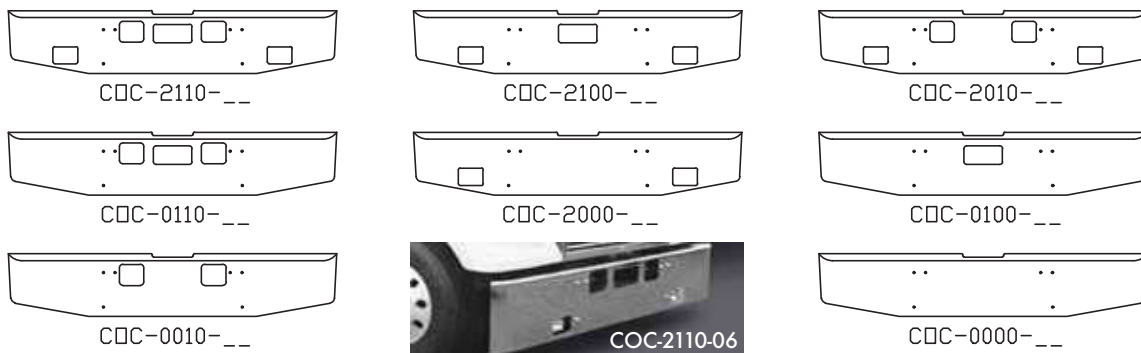

### 2010 AND NEWER CORONADO (high ground clearance)

(wider than 12" requires COC brackets)

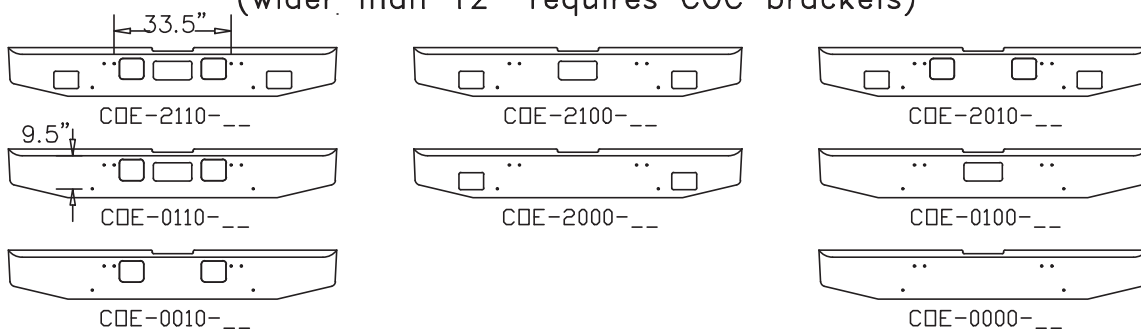

AVAILABLE STYLES (see page 7 for more styles)

ROLLED END  
SQUARE

12"=-04  
16"=-05  
18"=-96

Bumpers shown below are for MOUNTING and OPTIONS. To select a style use the two digit outside shape shown above as the last two digits of the part number.

### 1986-1995 FLC112 SET BACK AXLE W/16" break-back

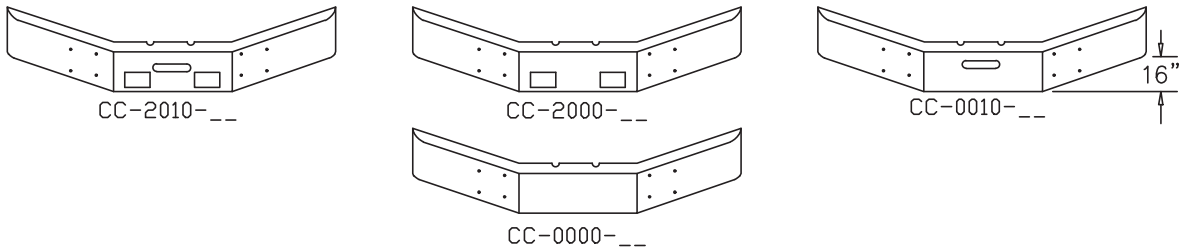

### 1986-1995 CONV. SET BACK AXLE W/17" break-back FLC 120 SERIES

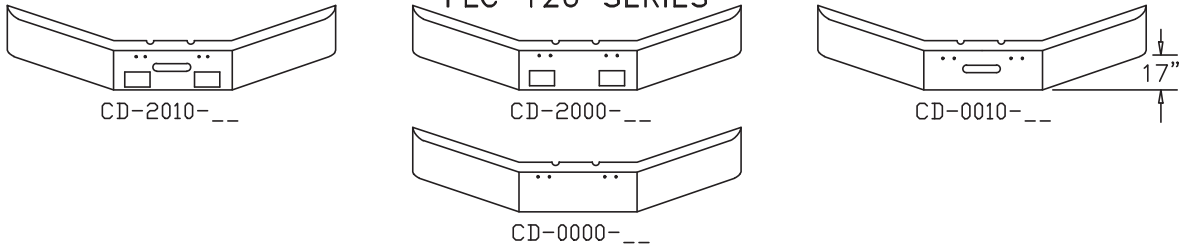

### 1989-1996 FLD 112 SEVERE DUTY SET BACK AXLE W/17" break-back

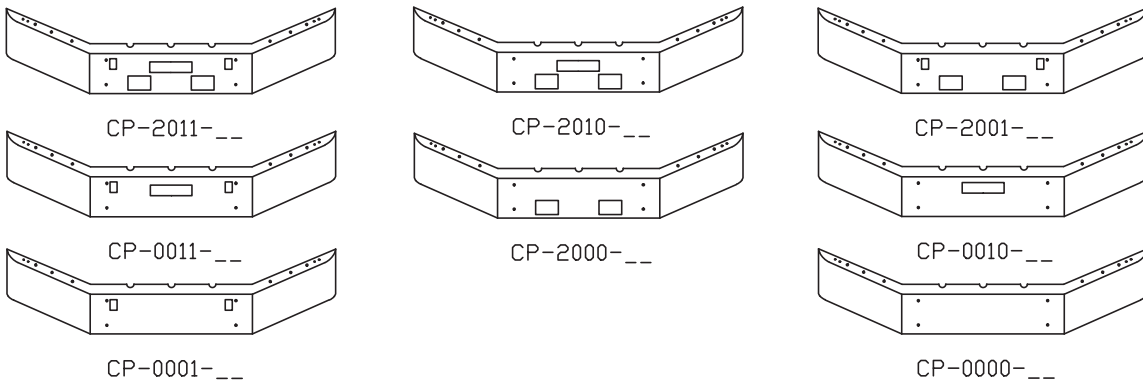

**No WARRANTY on break-backs over 18"**

## AVAILABLE STYLES (see page 7 for more styles)

<p>CF, CE</p> <div style="border: 1px solid black; padding: 2px; display: inline-block;">TAPERED</div> <p>12"=-01 16"=-02 18"=-03 20"=-31 22"=-32</p>	<p>CE</p> <div style="border: 1px solid black; padding: 2px; display: inline-block;">GULLWING</div> <p>16"=-07</p>	<p>CF, CE</p> <div style="border: 1px solid black; padding: 2px; display: inline-block;">ROLLED END SQUARE</div> <p>12"=-04 16"=-05 18"=-06 20"=-41 22"=-42</p>
---	--	---

Bumpers shown below are for MOUNTING and OPTIONS. To select a style use the two digit outside shape shown above as the last two digits of the part number.

### 1989 AND NEWER COE W/7" break-back (Not available in gullwing -07)

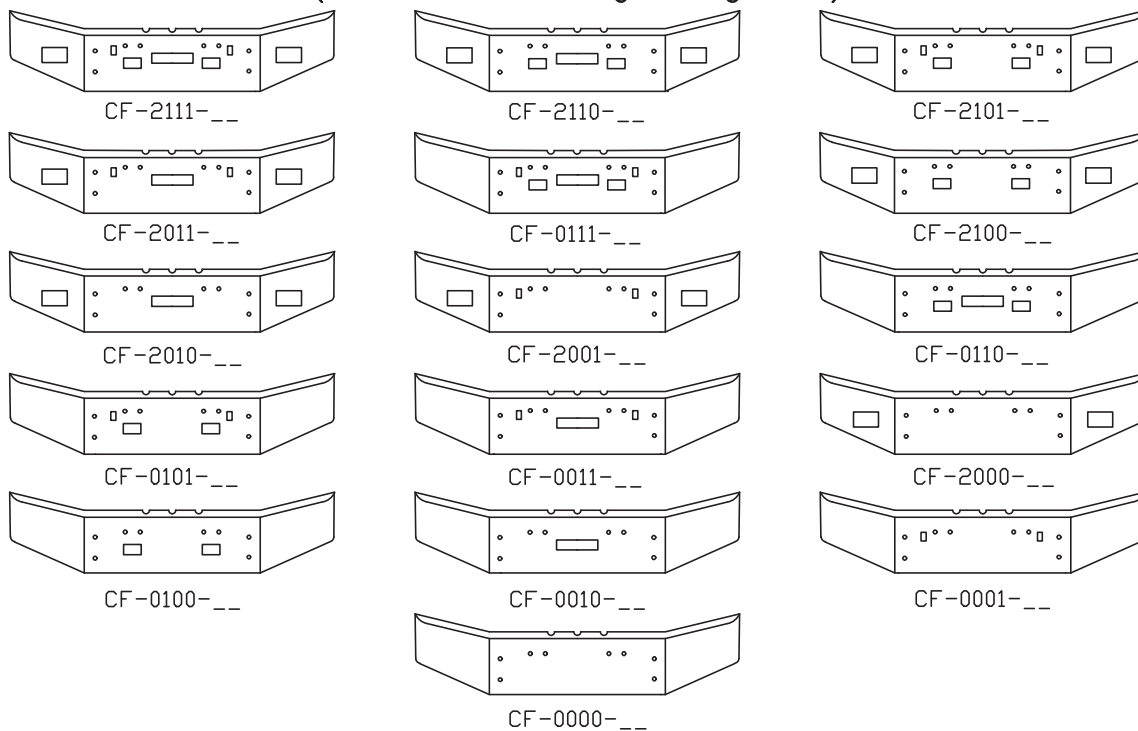

### 1986 AND NEWER CONV. SET BACK AXLE W/2" break-back FLC 112 CONV. (STEEL CAB available in gullwing -07 only)

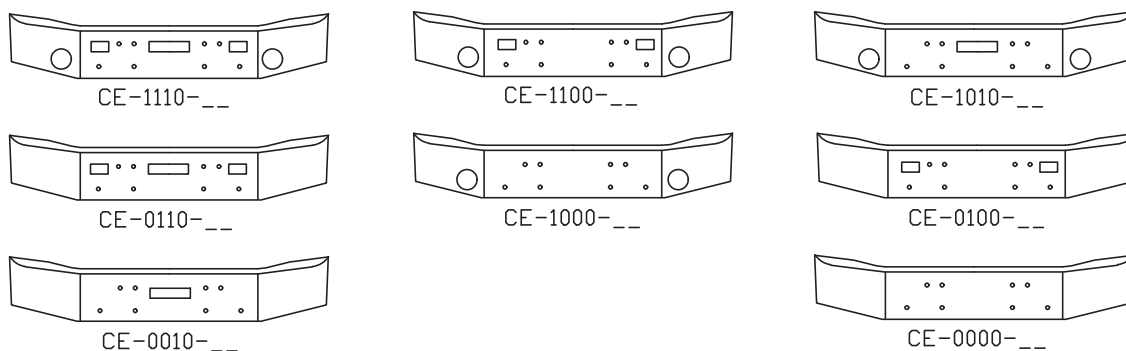

AVAILABLE STYLES (see page 7 for more styles)



- 12"=-04
- 16"=-05
- 18"=-96
- 20"=-97
- 22"=-98

Bumpers shown below are for MOUNTING and OPTIONS. To select a style use the two digit outside shape shown above as the last two digits of the part number.

For full length 92" bumpers not using end caps, add "92" to end of part number.  
Example: CG-2011-04-92"

**FLD 112 W/6" break-back**  
86<sup>3</sup>/<sub>4</sub>" long use with factory plastic ends (not included)

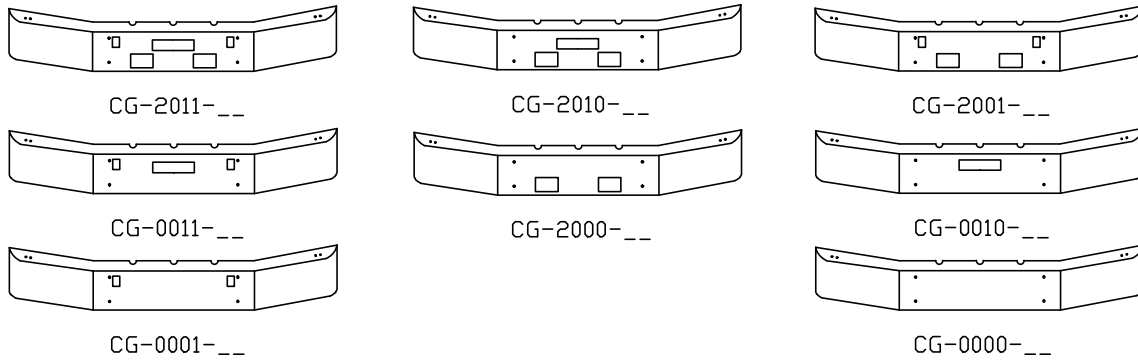

**FLD 120 W/6" break-back**  
86<sup>3</sup>/<sub>4</sub>" long use with factory plastic ends (not included)  
(please check next category before ordering)

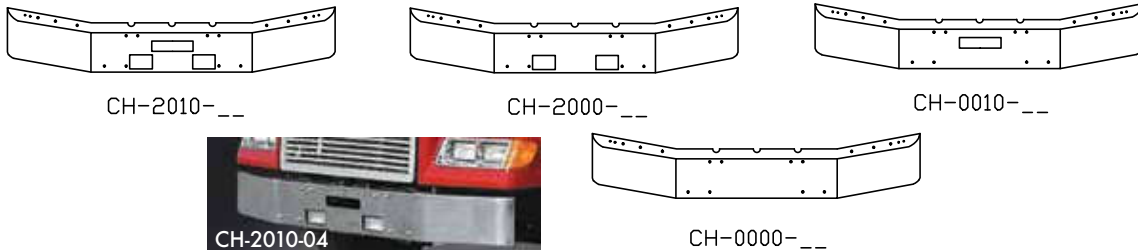

**FLD 120 W/6" break-back**  
86<sup>3</sup>/<sub>4</sub>" long use with factory plastic ends (not included)  
(please check prior category before ordering)

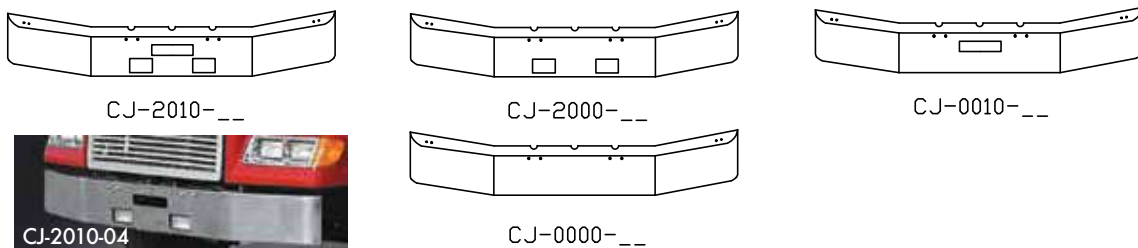

**No WARRANTY on break-backs over 18"**

AVAILABLE STYLES (see page 7 for more styles)



Bumpers shown below are for MOUNTING and OPTIONS. To select a style use the two digit outside shape shown above as the last two digits of the part number.

COMBINATION OF FLD 112 & FLD120 BOLT PATTERNS  
W/6" break-back

86<sup>3</sup>/<sub>4</sub>" long use with factory plastic ends (not included)

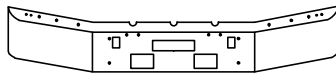

CM-2011-\_\_

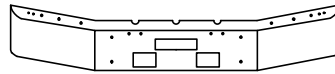

CM-2010-\_\_

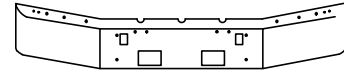

CM-2001-\_\_

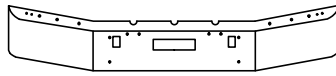

CM-0011-\_\_

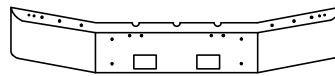

CM-2000-\_\_

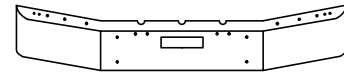

CM-0010-\_\_

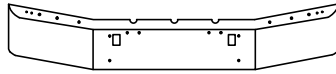

CM-0001-\_\_

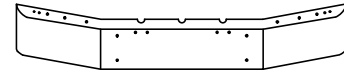

CM-0000-\_\_

**No WARRANTY on break-backs over 18"**





## AVAILABLE STYLES (see page 7 for more styles)

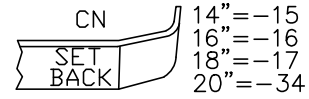
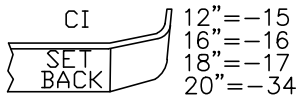

Bumpers shown below are for MOUNTING and OPTIONS. To select a style use the two digit outside shape shown above as the last two digits of the part number.

### 1989 AND NEWER CONVENTIONAL SET BACK AXLE (Chrome Replacement) FLD 112, FLD120 (brackets included)

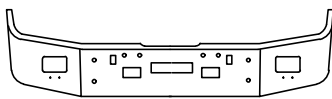

CI-2111--

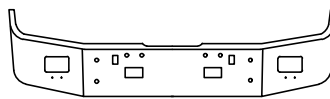

CI-2110--

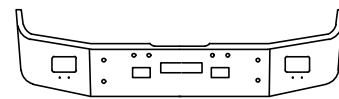

CI-2101--

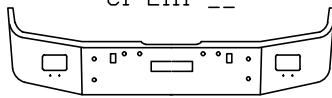

CI-2011--

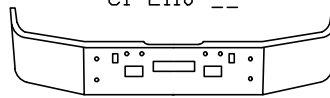

CI-0111--

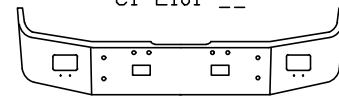

CI-2100--

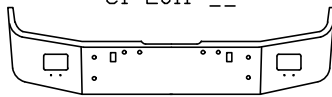

CI-2010--

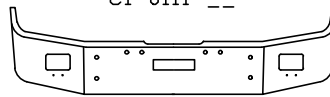

CI-2001--

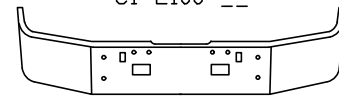

CI-0110--

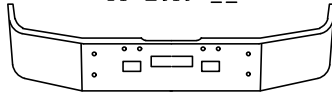

CI-0101--

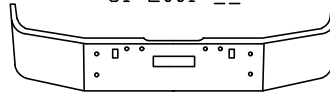

CI-0011--

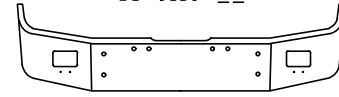

CI-2000--

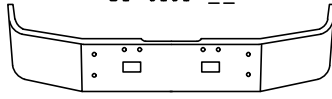

CI-0100--

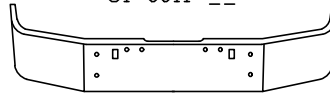

CI-0010--

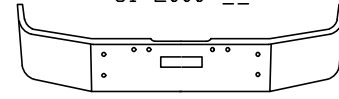

CI-0001--

**Replacement Brackets, if needed:**

12" bumper	CI0115BK
16" bumper	CI0116BK
18" bumper	CI0117BK
20" bumper	CI0134BK

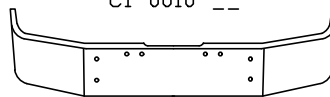

CI-0000--



### PRIOR TO 2004 COLUMBIA SET BACK AXLE (Chrome Replacement) (brackets included)

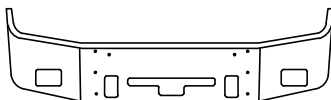

CN-2011--

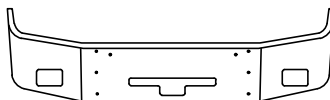

CN-2001--

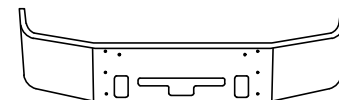

CN-0011--

**Replacement Brackets, if needed:**

14" bumper	CN0115BK
16" bumper	CN0116BK
18" bumper	CN0117BK
20" bumper	CN0134BK

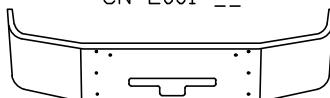

CN-0001--



**No WARRANTY on break-backs over 18"**

## AVAILABLE STYLES (see page 7 for more styles)

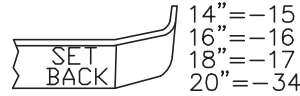

Bumpers shown below are for MOUNTING and OPTIONS. To select a style use the two digit outside shape shown above as the last two digits of the part number.

### CONVENTIONAL SET BACK AXLE (Chrome Replacement) 1996-2004 CENTURY CLASS (Brackets Included)

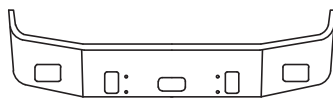

CL-2210-\_\_

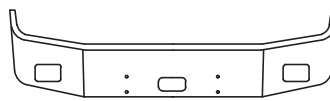

CL-2200-\_\_

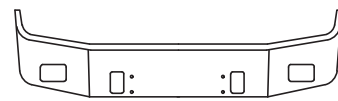

CL-2010-\_\_

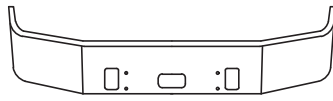

CL-0210-\_\_



CL-0210-15

AIR FOIL



CL-AF

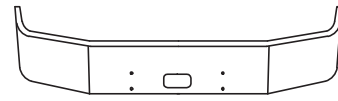

CL-0200-\_\_

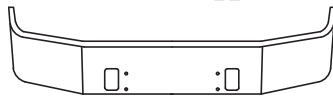

CL-0010-\_\_

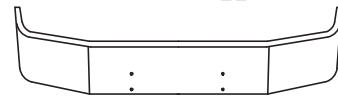

CL-0000-\_\_

**Replacement Brackets, if needed:**

14" bumper	CL0115BK
16" bumper	CL0116BK
18" bumper	CL0117BK
20" bumper	CL0134BK

**No WARRANTY on break-backs over 18"**

### CONVENTIONAL SET BACK AXLE (Chrome Replacement) 2005-2007 CENTURY CLASS (Brackets Included) 2004-2007 COLUMBIA

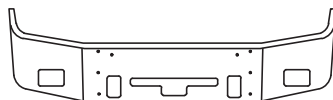

CW-2011-\_\_



CW-2010-\_\_

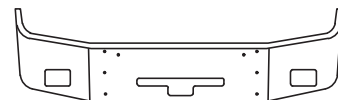

CW-2001-\_\_

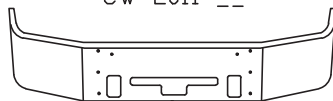

CW-0011-\_\_



CW-0011-15

AIR FOIL



CW-AF

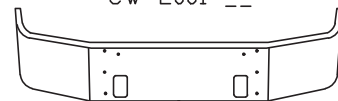

CW-0010-\_\_

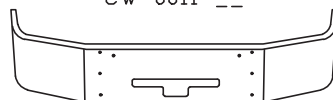

CW-0001-\_\_

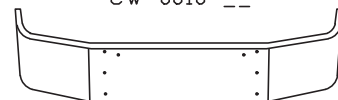

CW-0000-\_\_

**Replacement Brackets, if needed:**

14" bumper	CW0115BK
16" bumper	CW0116BK
18" bumper	CW0117BK
20" bumper	CW0134BK

**No WARRANTY on break-backs over 18"**

AVAILABLE STYLES (see page 7 for more styles)

COA, COB are not available in 12" or 16"

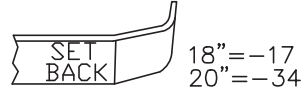

Bumpers shown below are for MOUNTING and OPTIONS. To select a style use the two digit outside shape shown above as the last two digits of the part number.

CONVENTIONAL SET BACK AXLE (Replaces Plastic Only)  
2008 AND NEWER COLUMBIA (Brackets Included)  
(for glider check CW series)

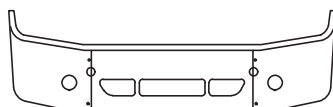

COA-1011-\_\_



COA-1010-\_\_

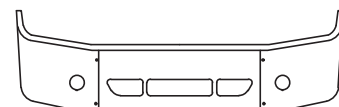

COA-1001-\_\_

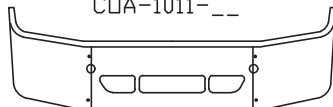

COA-0011-\_\_



COA-0011-17

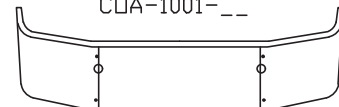

COA-0010-\_\_

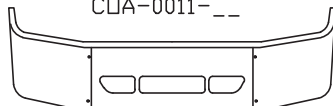

COA-0001-\_\_



AIR FOIL

COA-AF

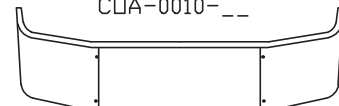

COA-0000-\_\_

Replacement Brackets, if needed:

18" bumper	COA0117BK
20" bumper	COA0134BK

**No WARRANTY on break-backs over 18"**

CONVENTIONAL SET BACK AXLE (Chrome Replacement)  
2008 AND NEWER CENTURY CLASS (Brackets Included)  
2008 & NEWER COLUMBIA (Replaces Stainless Clad, Brkts Included)

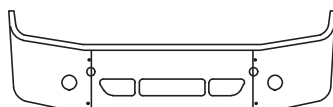

COB-1011-\_\_



COB-1010-\_\_

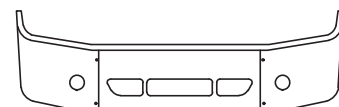

COB-1001-\_\_

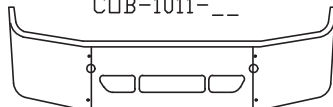

COB-0011-\_\_

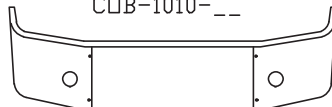

COB-1000-\_\_

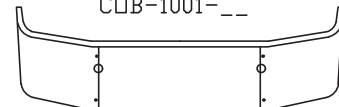

COB-0010-\_\_

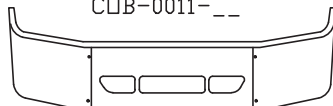

COB-0001-\_\_



COB-0011-17

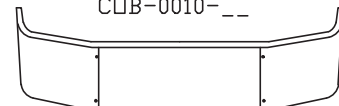

COB-0000-\_\_

Replacement Brackets, if needed:

18" bumper	COB0117BK
20" bumper	COB0134BK

**No WARRANTY on break-backs over 18"**

## AVAILABLE STYLES (see page 7 for more styles)



Bumpers shown below are for MOUNTING and OPTIONS. To select a style use the two digit outside shape shown above as the last two digits of the part number.

### CONVENTIONAL SET BACK AXLE (Replaces Plastic) 2008-2017 CASCADIA (Brackets Included) 3PC. BUMPER (extensions included fits factory air dam) 1400 SQ. INCH RADIATOR TRUCKS ONLY



CY-2011-\_\_

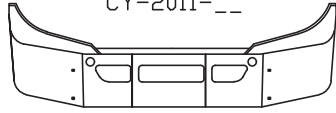

CY-0011-\_\_

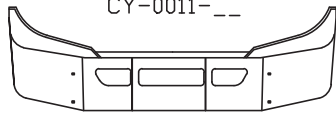

CY-0001-\_\_

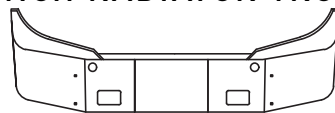

CY-2010-\_\_

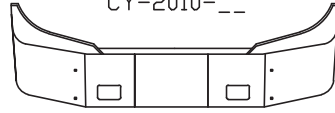

CY-2000-\_\_

Replacement Brackets, if needed:	
14" bumper	CY0215BK
16" bumper	CY0216BK
18" bumper	CY0217BK
20" bumper	CY0234BK
Replacement Extensions, if needed:	
Includes hardware	CY-EXT

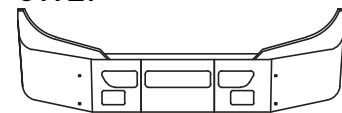

CY-2001-\_\_

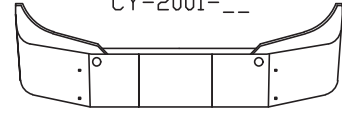

CY-0010-\_\_

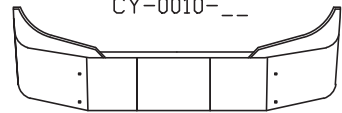

CY-0000-\_\_

**NOTE: OLDER DESIGN FLANGE - MOUNT BRACKETS**  
14" = CY0115BK, 16" = CY0116BK, ETC.

(shown with factory lights and wide vent for onguard radar)

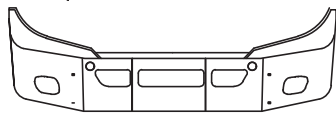

CY-5011-\_\_



CY-5012-15X



CY-AF

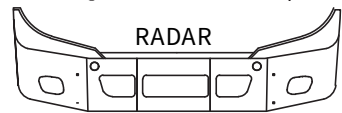

CY-5012-\_\_

### 2008-2017 CASCADIA (mounts to factory brackets) (Replaces Stainless Clad - brackets not included) 3PC. BUMPER (extensions included, fits factory air dam) 1400 SQ. INCH RADIATOR TRUCKS ONLY

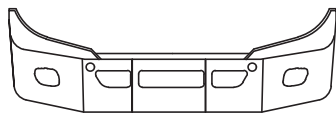

CDH-5011-\_\_

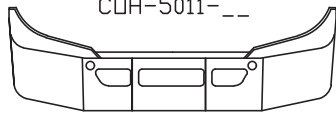

CDH-0011-\_\_

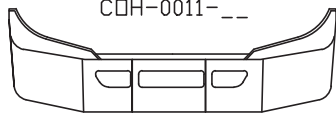

CDH-0001-\_\_



CDH-5010-\_\_

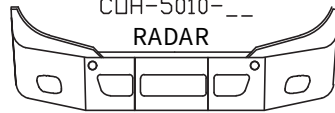

CDH-5012-\_\_



CDH-AF

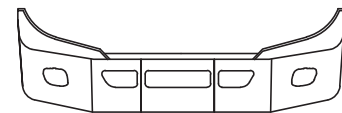

CDH-5001-\_\_

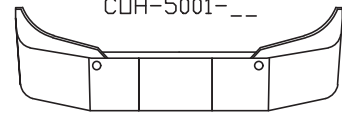

CDH-0010-\_\_

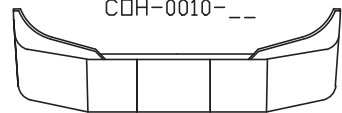

CDH-0000-\_\_

**No WARRANTY on break-backs over 18"**

## AVAILABLE STYLES (see page 7 for more styles)

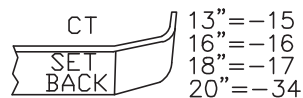
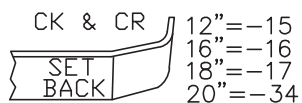

Bumpers shown below are for MOUNTING and OPTIONS. To select a style use the two digit outside shape shown above as the last two digits of the part number.

### 2002 AND OLDER FL 50, 60, 70, 80, (midrange)

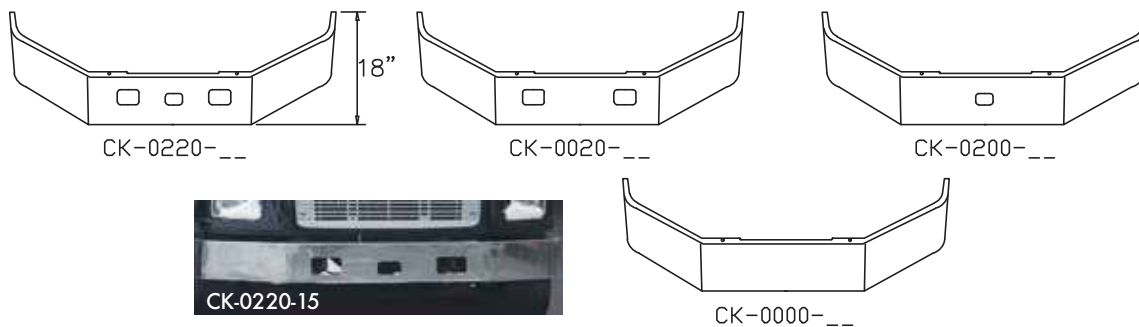

### 2002 AND OLDER FL112 (midrange) (Ends are 6" Longer than CK Model Check before ordering)

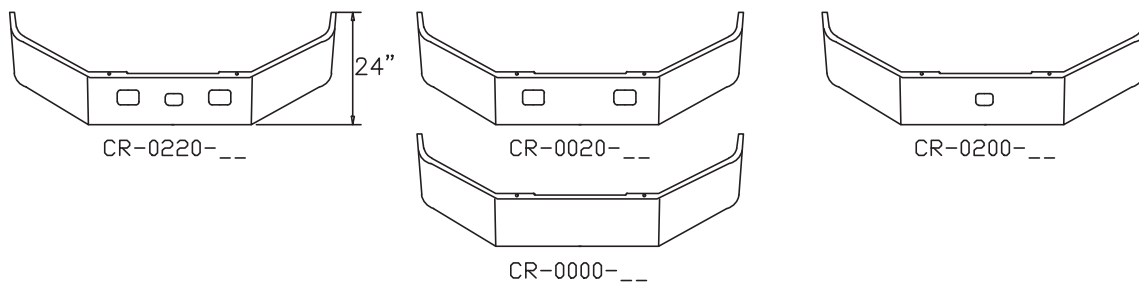

### 2003 AND NEWER BUSINESS CLASS M2 106 (midrange) FLUSH TOP FLANGE MOUNT – ALSO SEE COG SERIES NEXT PAGE PRIOR TO ORDERING



**No WARRANTY on break-backs over 18"**

## AVAILABLE STYLES (see page 7 for more styles)

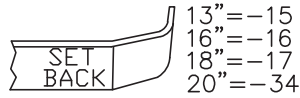

Bumpers shown below are for MOUNTING and OPTIONS. To select a style use the two digit outside shape shown above as the last two digits of the part number.

### 2003 & NEWER BUSINESS CLASS M2 112 (midrange)

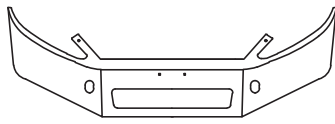

CDF-0011-\_\_

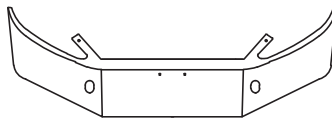

CDF-0010-\_\_

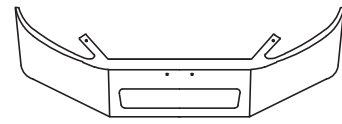

CDF-0001-\_\_

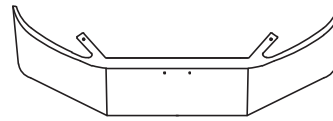

CDF-0000-\_\_

### 2011 AND NEWER BUSINESS CLASS M2 106 (midrange)

(COGmount brackets included & shown)

RECESSED TOP FLANGE MOUNT – ALSO SEE CT SERIES PREVIOUS PAGE PRIOR TO ORDERING

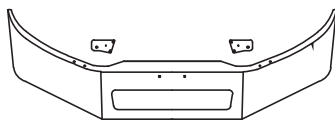

COG-0001-\_\_

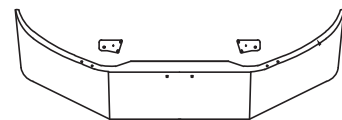

COG-0000-\_\_

### 2017 AND NEWER CASCADIA (Brackets Included)

3PC. BUMPER, TOW HOLES IN EXTENSIONS

REPLACES COMPOSITE BUMPERS ONLY

WILL NOT FIT FRAMES WITH WIDE RADIATORS

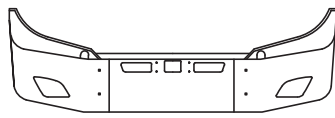

COJ-5011-\_\_-V6

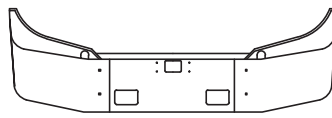

COJ-2010-\_\_-V6

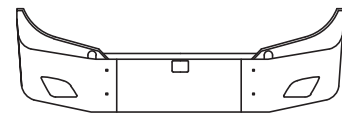

COJ-5010-\_\_-V7

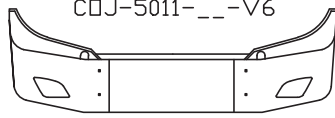

COJ-5010-\_\_

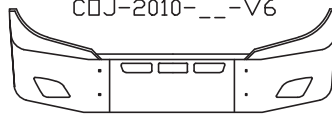

COJ-5001-\_\_

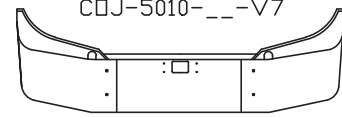

COJ-0010-\_\_-V6

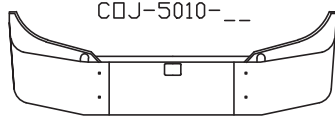

COJ-0010-\_\_-V7

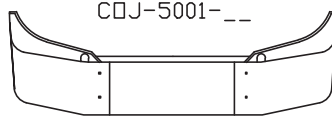

COJ-0010-\_\_



V6 = RADAR WITH PLASTIC COVER  
V7 = RADAR WITHOUT COVER

No WARRANTY on break-backs over 18"