

AVAILABLE STYLES (see page 7 for more styles)



12"=-01
16"=-02
18"=-03
20"=-31
22"=-32



12"=-09
16"=-10
18"=-11
20"=-51
22"=-52



12"=-04
16"=-05
18"=-06
20"=-41
22"=-42

Bumpers shown below are for MOUNTING and OPTIONS. To select a style use the two digit outside shape shown above as the last two digits of the part number.

1967-1986 CONV. 359, 1967-1980 COE 352

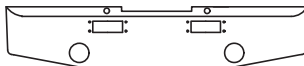

HA-1010-__

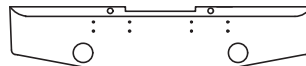

HA-1000-__

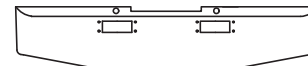

HA-0010-__

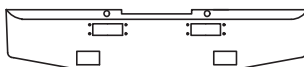

HA-2010-__



HA-2000-__

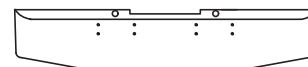

HA-0000-__

1987-2006 CONV. 378, 379, 357 SFA

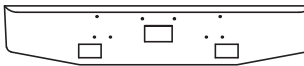

HC-2010-__

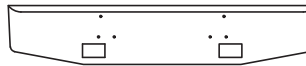

HC-2000-__

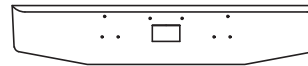

HC-0010-__

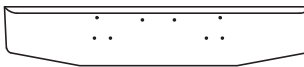

HC-0020-__



HC-0010-06



HC-0000-__

2007 AND NEWER CONV. 365, 367, 388, 389, 567

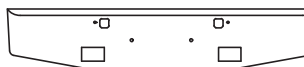

HV-2010-__

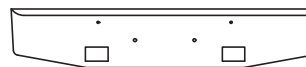

HV-2000-__

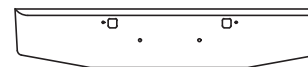

HV-0010-__

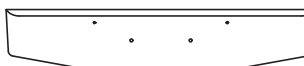

HV-0000-__



HV-0010-06

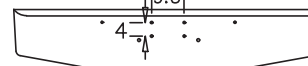

HV-0090-__

2010-NEWER CONV. 388 high ground clearance(Shown 12" width)

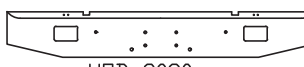

HOB-2090-__

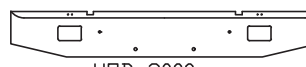

HOB-2000-__

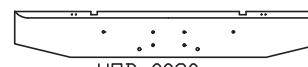

HOB-0090-__

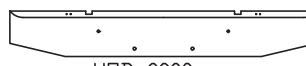

HOB-0000-__



VP120004



PB TOW PIN COVER - 378, 379 -
1987 & NEWER
FITS HC SERIES



VK120003

TOW PIN COVER - MOUNTS W/ HARDWARE - PAIR
FITS HV SERIES

AVAILABLE STYLES (see page 7 for more styles)

 <p>TAPERED</p>	12"=-01	 <p>BOXED END</p>	12"=-09	 <p>ROLLED END SQUARE</p>	12"=-04
	16"=-02		16"=-10		16"=-05
	18"=-03		18"=-11		18"=-06
	20"=-31		20"=-51		20"=-41
	22"=-32		22"=-52		22"=-42

Bumpers shown below are for MOUNTING and OPTIONS. To select a style use the two digit outside shape shown above as the last two digits of the part number.

1987 AND NEWER CONV. 375 W/2" break-back
(check HI pattern before ordering)

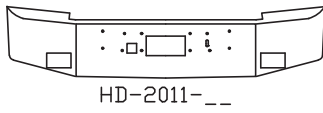

HD-2011-__

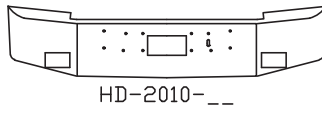

HD-2010-__



HD-2001-__

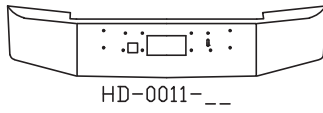

HD-0011-__

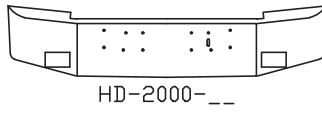

HD-2000-__

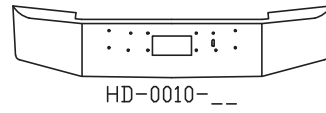

HD-0010-__

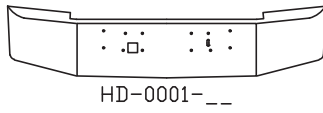

HD-0001-__

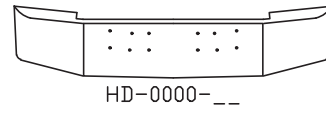

HD-0000-__

PRIOR TO 1987 LOGGER

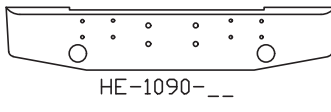

HE-1090-__

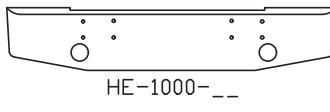

HE-1000-__

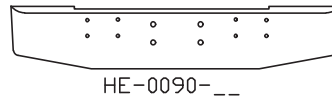

HE-0090-__

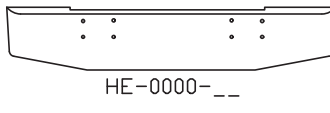

HE-0000-__

1987 AND NEWER LOGGER

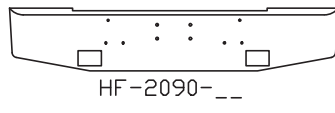

HF-2090-__

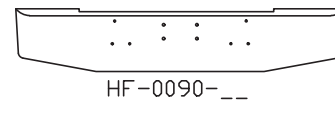

HF-0090-__

AVAILABLE STYLES (see page 7 for more styles)

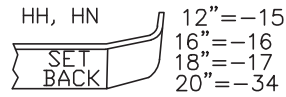
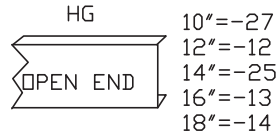

Bumpers shown below are for MOUNTING and OPTIONS. To select a style use the two digit outside shape shown above as the last two digits of the part number.

357 LOGGER W/19" break-back w/open ends

378 SET BACK AXLE (diamond plate available on request)

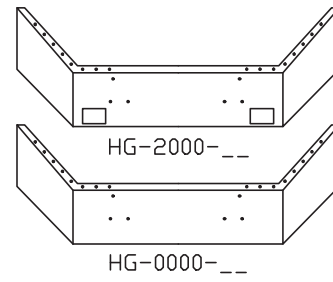
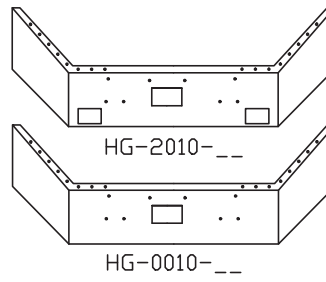
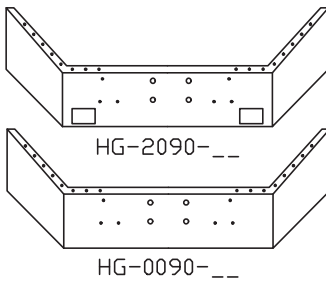

TOP PLATES FOR HG BUMPER (specify Valley or Factory)

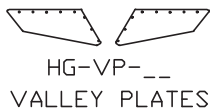

HG-__-AD
(alum. diamond)

HG-__-CS
(chrome)

HG-__-SS
(stainless)



1987-1996 CONV. 377, PRIOR TO 1991 377AE SET BACK AXLE (brackets included, check HN pattern before ordering)

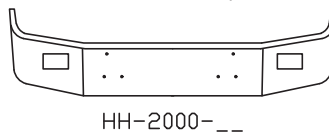
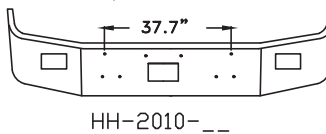

Replacement Brackets, if needed:	
12" bumper	HHO115BK
16" bumper	HHO116BK
18" bumper	HHO117BK
20" bumper	HHO134BK

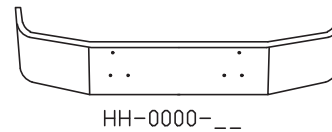

1997 377AE SET BACK AXLE (brackets included) (check HH pattern before ordering)

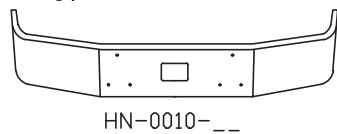
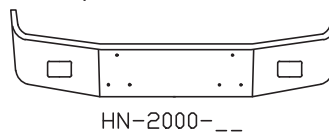
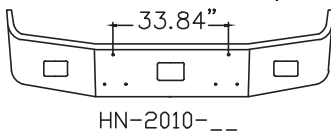

Replacement Brackets, if needed:	
12" bumper	HNO115BK
16" bumper	HNO116BK
18" bumper	HNO117BK
20" bumper	HNO134BK

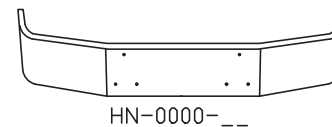

No WARRANTY on break-backs over 18"

AVAILABLE STYLES (see page 7 for more styles)

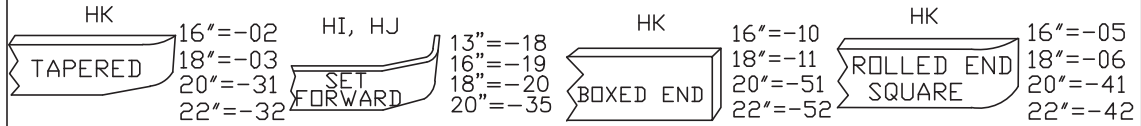

Bumpers shown below are for MOUNTING and OPTIONS. To select a style use the two digit outside shape shown above as the last two digits of the part number.

PRIOR TO 1991 CONV. 377 SET FORWARD

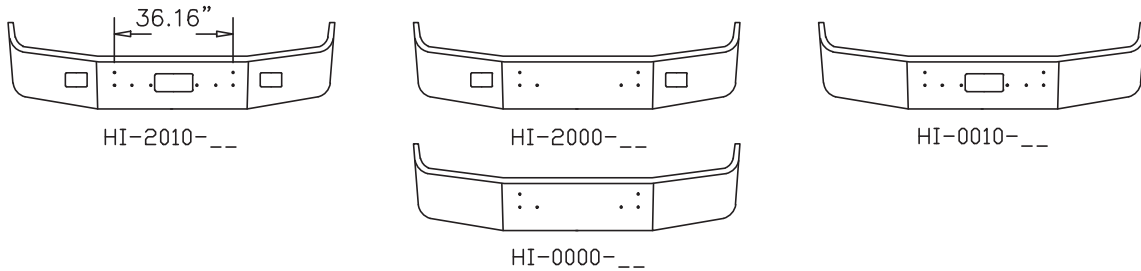

1991 AND NEWER CONV. 377AE, 375 SET FORWARD AXLE

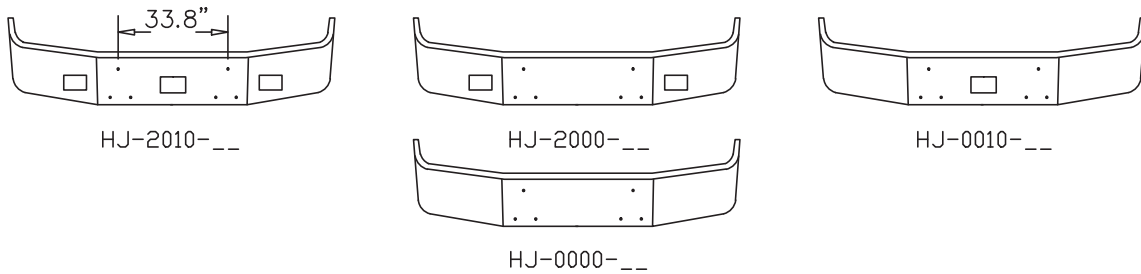

**1981 AND NEWER 362 COE
(Not available in 12" width)**

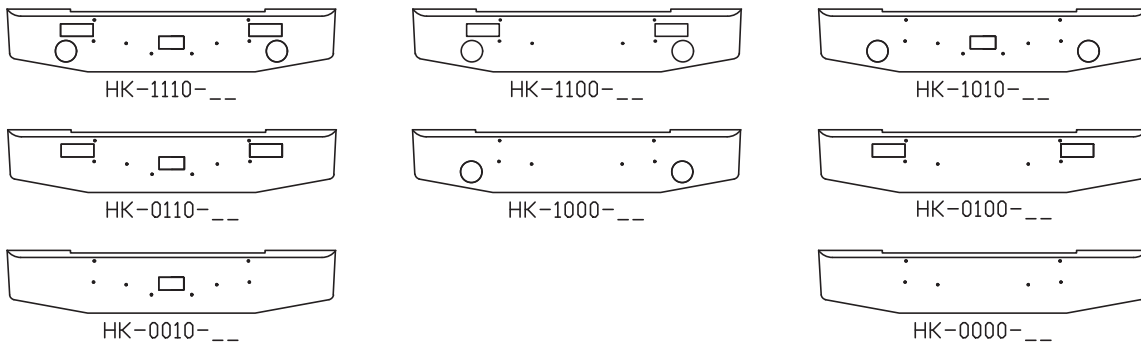

No WARRANTY on break-backs over 18"

AVAILABLE STYLES (see page 7 for more styles)



Bumpers shown below are for MOUNTING and OPTIONS. To select a style use the two digit outside shape shown above as the last two digits of the part number.

385 CONVENTIONAL SET BACK AXLE 112" BBC

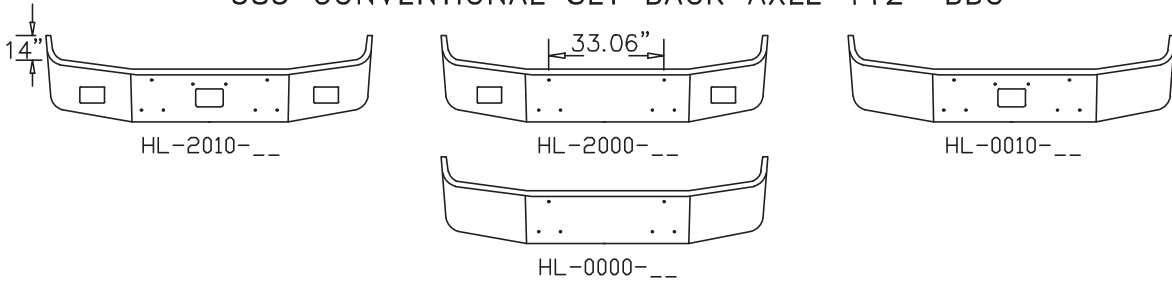

385 CONVENTIONAL SET BACK AXLE 120" BBC

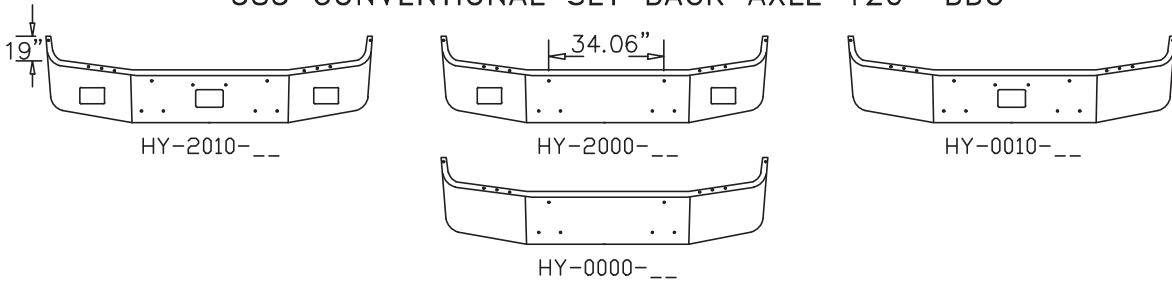

320 COE (available in 14"-25 only)

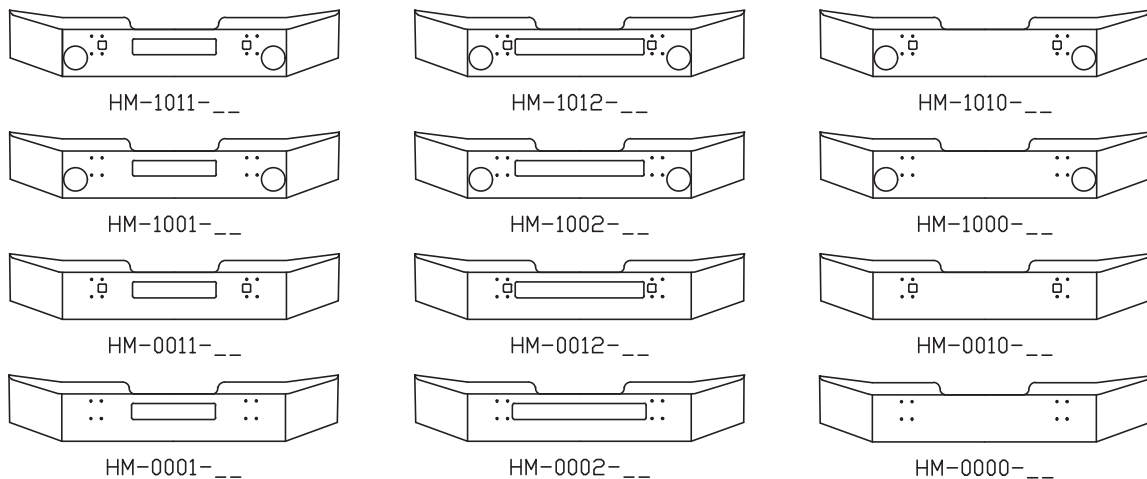

No WARRANTY on break-backs over 18"

AVAILABLE STYLES (see page 7 for more styles)

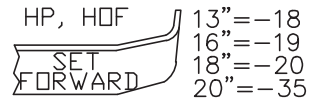
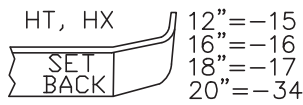

Bumpers shown below are for MOUNTING and OPTIONS. To select a style use the two digit outside shape shown above as the last two digits of the part number.

1997 – 2005 330 SET FORWARD AXLE (90° Top flange only)
WITH 12K/14K RATED FRONT AXLE

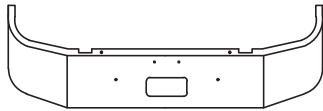

HP-0010-__

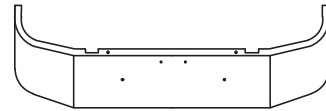

HP-0000-__

2006 – 2014 MODELS 330, 335, 340, 348
WITH 12K/14K RATED FRONT AXLE (BRACKETS INCLUDED)

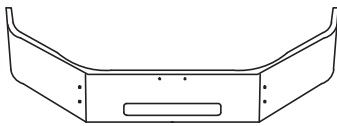

HT-0010-__

Replacement Brackets, if needed:	
12" bumper	HTO115BK
16" bumper	HTO116BK
18" bumper	HTO117BK
20" bumper	HTO134BK

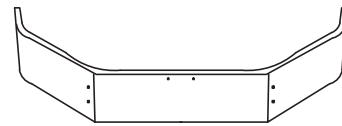

HT-0000-__

2006 – 2014 MODELS 330, 335, 340, 348
WITH 16K RATED FRONT AXLE (BRACKETS NOT INCLUDED)

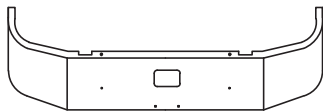

HDF-0010-__

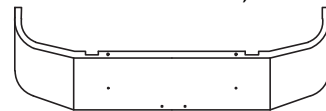

HDF-0000-__

2007 AND NEWER 367, 567 SET BACK AXLE (brkts not included)

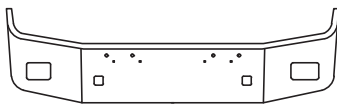

HX-2010-__

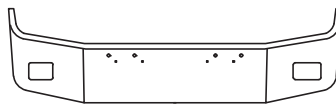

HX-2000-__

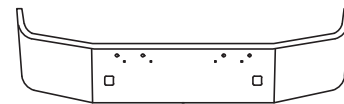

HX-0010-__

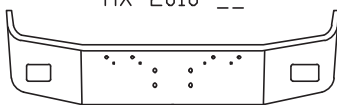

HX-2090-__

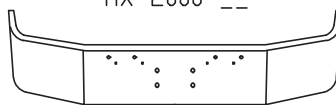

HX-0090-__

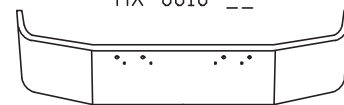

HX-0000-__

TOP PLATES FOR HX BUMPER (fits Valley & Factory bumper)



HX-VP-__

HX-VP-AD HX-VP-CS HX-VP-SS
(alum. diamond) (chrome) (stainless)

No WARRANTY on break-backs over 18"

AVAILABLE STYLES (see page 7 for more styles)

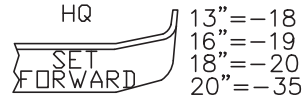
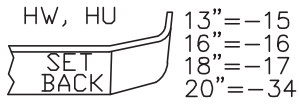

Bumpers shown below are for MOUNTING and OPTIONS. To select a style use the two digit outside shape shown above as the last two digits of the part number.

362E SET FORWARD AXLE



HQ-2210-__



HQ-2200-__

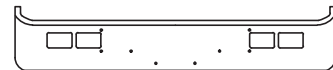

HQ-2010-__

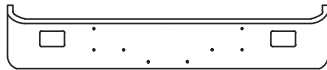

HQ-2000-__



HQ-0210-__



HQ-0200-__

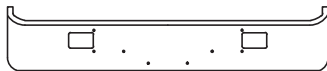

HQ-0010-__

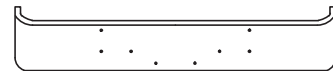

HQ-0000-__

2008 AND NEWER 384 SET BACK AXLE (brackets not included) (clad replacement, hw-mb brkts required for plastic replacement)

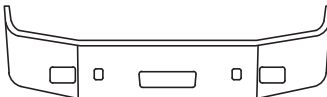

HW-2011-__



HW-2010-__

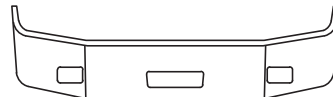

HW-2001-__

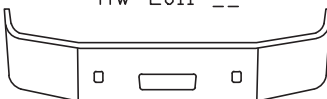

HW-0011-__

Replacement Brackets, if needed:	
13" bumper	HW0115BK
16" bumper	HW0116BK
18" bumper	HW0117BK
20" bumper	HW0134BK

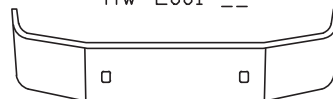

HW-0010-__

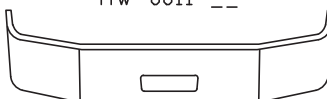

HW-0001-__

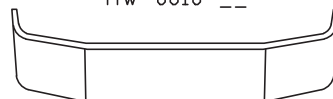

HW-0000-__



2006 & NEWER 386 SET BACK AXLE (brackets included) (standard width 16" Not available in less than 16" width)



HU-2010-__



HU-0000-__

No WARRANTY on break-backs over 18"

AVAILABLE STYLES (see page 7 for more styles)

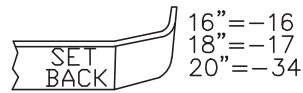

Bumpers shown below are for MOUNTING and OPTIONS. To select a style use the two digit outside shape shown above as the last two digits of the part number.

1999-2001 387 SET BACK AXLE (brackets included)

(standard width 16" Not available in less than 16" width)

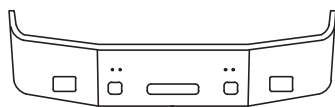

HR-2210-__



HR-0210-__

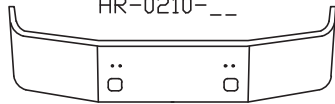

HR-0010-__



HR-2200-__

Replacement Brackets, if needed:	
16" bumper	HR0116BK
18" bumper	HR0117BK
20" bumper	HR0134BK

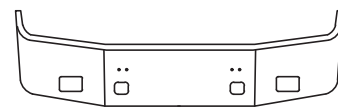

HR-2010-__



HR-0200-__

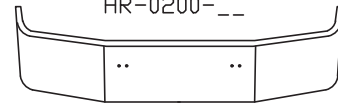

HR-0000-__

2002-2010 387 SET BACK AXLE (brackets included)

(standard width 16" Not available in less than 16" width)

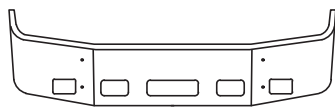

HS-2210-__

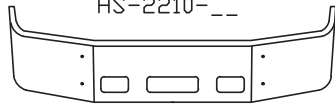

HS-0210-__

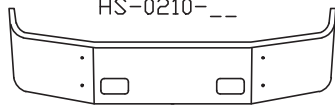

HS-0010-__

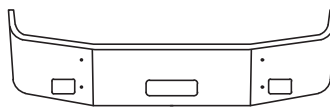

HS-2200-__

Replacement Brackets, if needed:	
16" bumper	HS0116BK
18" bumper	HS0117BK
20" bumper	HS0134BK

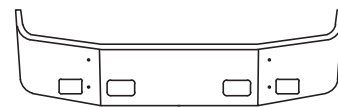

HS-2010-__



HS-0200-__

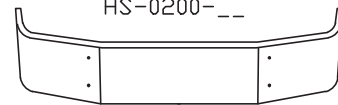

HS-0000-__

No WARRANTY on break-backs over 18"

AVAILABLE STYLES (see page 7 for more styles)



Bumpers shown below are for MOUNTING and OPTIONS. To select a style use the two digit outside shape shown above as the last two digits of the part number.

2012 & NEWER 579 SET BACK AXLE (Chrome Replacement)

Available with square or factory round lights (brackets included)

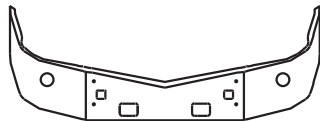

HZ-5110-__

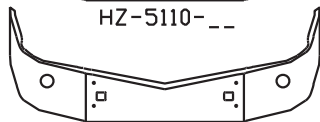

HZ-5010-__

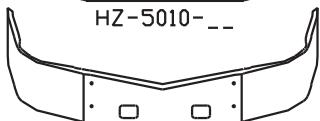

HZ-0100-__

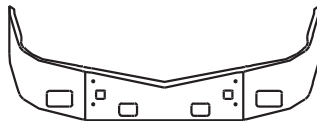

HZ-2110-__



HZ-0110-__

AIR FOIL



HZ-AF



HZ-5100-__

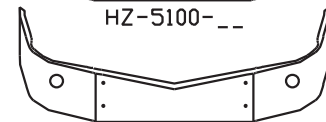

HZ-5000-__



HZ-0110-16Y

Replacement Brackets, if needed:	
16" bumper	HZO116BK
18" bumper	HZO117BK
20" bumper	HZO134BK
Replacement Extensions, if needed:	
Includes hardware	HZ-EXT

2012 & NEWER 587 SET BACK AXLE (Chrome Replacement)

Available with square or factory round lights (brackets included)



HQA-5110-__

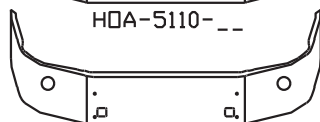

HQA-5010-__

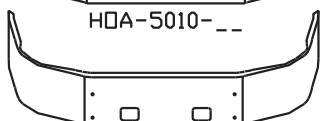

HQA-0100-__



HQA-2110-__

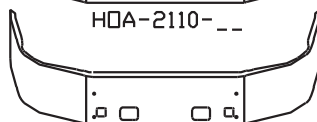

HQA-0110-__

AIR FOIL



HQA-AF



HQA-5100-__

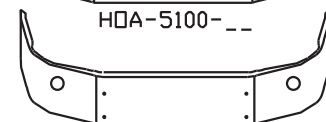

HQA-5000-__

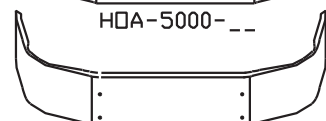

HQA-0000-__

Replacement Brackets, if needed:	
16" bumper	HQA0116BK
18" bumper	HQA0117BK
20" bumper	HQA0134BK



HQA-0010-16

No WARRANTY on break-backs over 18"

AVAILABLE STYLES (see page 7 for more styles)

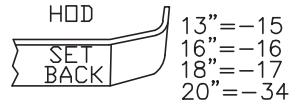
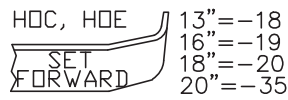

Bumpers shown below are for MOUNTING and OPTIONS. To select a style use the two digit outside shape shown above as the last two digits of the part number.

2015 AND NEWER 337 SET FORWARD AXLE (brkts included)



HOC-2010-__



HOC-2000-__



HOC-0010-__



HOC-0010-18

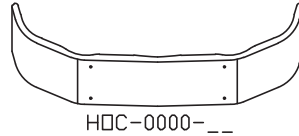

HOC-0000-__

Replacement Brackets, if needed:	
16" bumper	HOC0119BK
18" bumper	HOC0120BK
20" bumper	HOC0135BK

2005 AND NEWER 357, 378 SET BACK AXLE (Chrome Replacement)

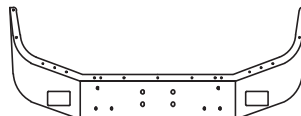

HOD-2090-__



HOD-2010-__

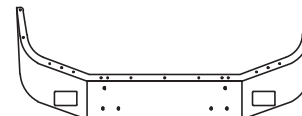

HOD-2000-__

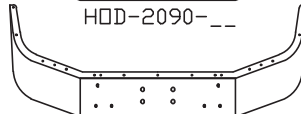

HOD-0090-__



HOD-0010-__

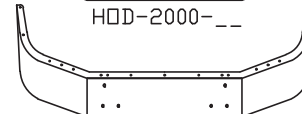

HOD-0000-__

TOP PLATES FOR HOD



HOD-VP-__

HOD-VP-AD
(alum. diamond)

HOD-VP-CS
(chrome)

HOD-VP-SS
(stainless)

2016 AND NEWER 348 SET FORWARD AXLE

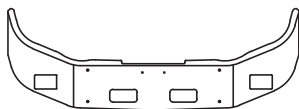

HOE-2010-__



HOE-2000-__

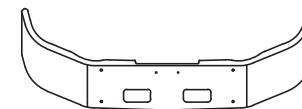

HOE-0010-__



HOE-0010-18

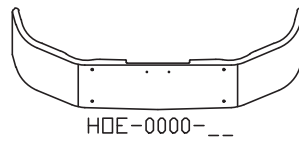

HOE-0000-__

Replacement Brackets, if needed:	
16" bumper	HOE0119BK
18" bumper	HOE0120BK
20" bumper	HOE0135BK

No WARRANTY on break-backs over 18"