



AVAILABLE STYLES (see page 7 for more styles)

 TAPERED	12"=-01	 BOXED END	12"=-09	 ROLLED END SQUARE	12"=-04
	16"=-02		16"=-10		16"=-05
	18"=-03		18"=-11		18"=-06
	20"=-31		20"=-51		20"=-41
	22"=-32		22"=-52		22"=-42

Bumpers shown below are for MOUNTING and OPTIONS. To select a style use the two digit outside shape shown above as the last two digits of the part number.

COE W/2" break-back (not available in 12" width)

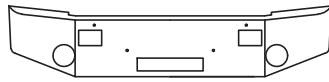

IA-1110-__

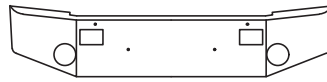

IA-1100-__

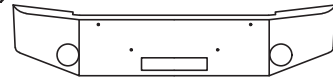

IA-1010-__



IA-0110-__

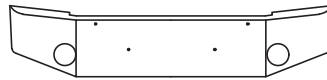

IA-1000-__

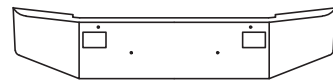

IA-0100-__

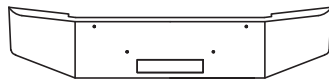

IA-0010-__

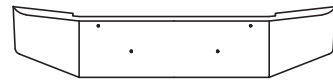

IA-0000-__

CONVENTIONAL WESTERN STAR



IB-1010-__



IB-1000-__



IB-0010-__



IB-0000-__

1989-2007 CONV. 4900 SERIES, CONSTELLATION, LOWMAXX, HERITAGE



IC-2010-__

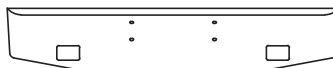

IC-2000-__

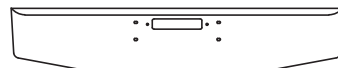

IC-0010-__



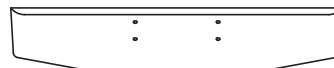

IC-2010-06



IC-0000-__

No WARRANTY on break-backs over 18"

AVAILABLE STYLES (see page 7 for more styles)

 TAPERED	12"=-01	 BOXED END	12"=-09	 ROLLED END SQUARE	12"=-04
	16"=-02		16"=-10		16"=-05
	18"=-03		18"=-11		18"=-06
	20"=-31		20"=-51		20"=-41
	22"=-32		22"=-52		22"=-42

Bumpers shown below are for MOUNTING and OPTIONS. To select a style use the two digit outside shape shown above as the last two digits of the part number.

1985-1988 WESTERN STAR

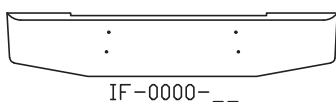
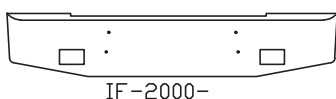
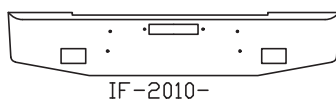

2008 AND NEWER 4900 SERIES SET FORWARD (not available in 12")

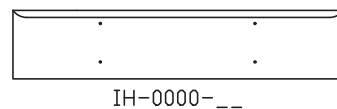
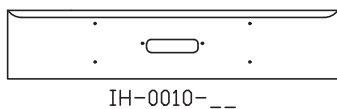
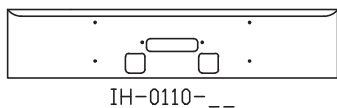
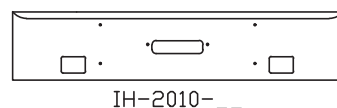
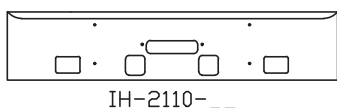

3.88"

2013 AND NEWER 4700SF (not available in 12")

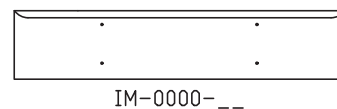
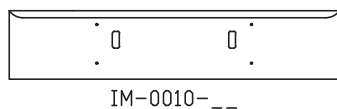
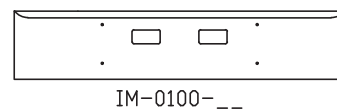
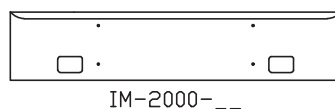
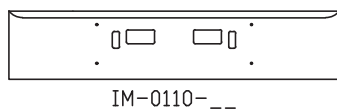
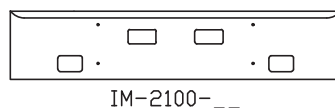
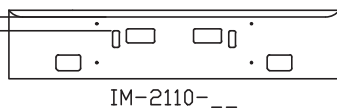

No WARRANTY on break-backs over 18"

AVAILABLE STYLES (see page 7 for more styles)

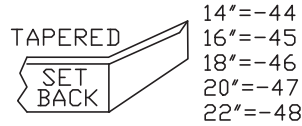

Bumpers shown below are for MOUNTING and OPTIONS. To select a style use the two digit outside shape shown above as the last two digits of the part number.

2007 AND OLDER 4900SA

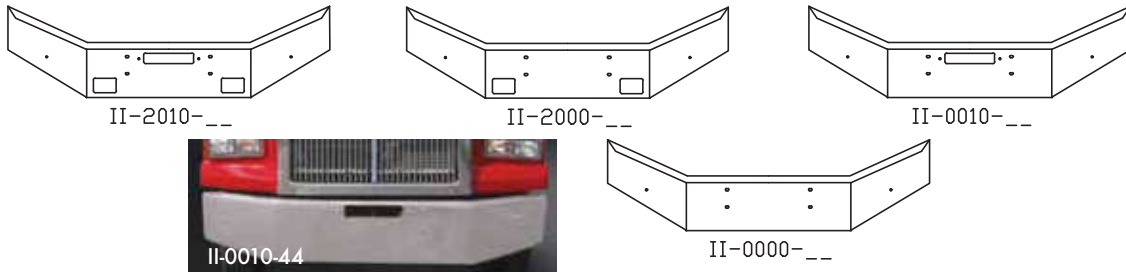

2008 AND NEWER 4900SA

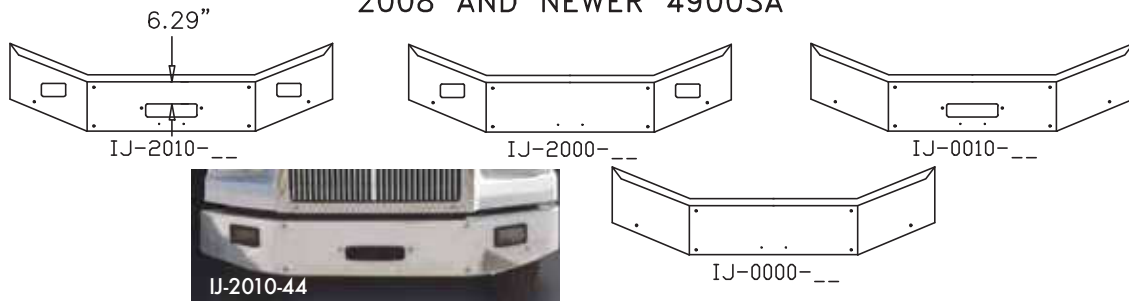

2008-2009 4964FX (CHECK CENTER HOLE LOCATION)



2008-2009 4964FX (CHECK CENTER HOLE LOCATION)



No WARRANTY on break-backs over 18"

AVAILABLE STYLES (see page 7 for more styles)



14"=-15
16"=-16
18"=-17



16"=-708
18"=-709
20"=-711

Bumpers shown below are for MOUNTING and OPTIONS. To select a style use the two digit outside shape shown above as the last two digits of the part number

WESTERN STAR 4700SB

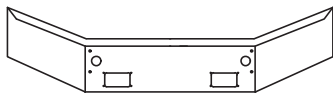

IN-2010-__

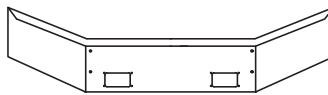

IN-2000-__

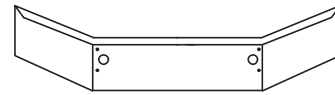

IN-0010-__



IN-2010-15

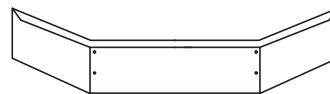

IN-0000-__

2015 AND NEWER 5700XE SERIES SET BACK AXLE (Shown with -V5 front radar cutout) (only fits 1400 sq. in radiator applications)

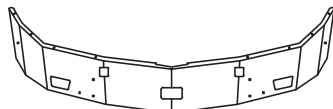

IO-5010-708-V5



IO-5011-708



IO-5000-708-V5

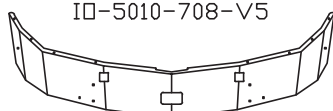

IO-0010-708-V5

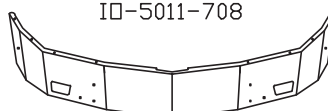

IO-5000-708

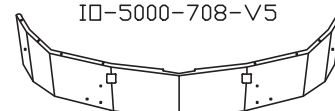

IO-0010-708

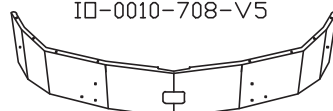

IO-0000-708-V5

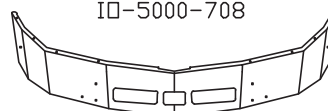

IO-0011-708

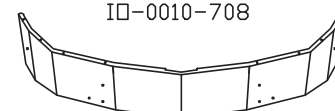

IO-0000-708



IO-0010-708-V5

Replacement Brackets, if needed:	
16" bumper	IO01708BK
18" bumper	IO01709BK
20" bumper	IO01711BK

No WARRANTY on break-backs over 18"